

# APRIL 180

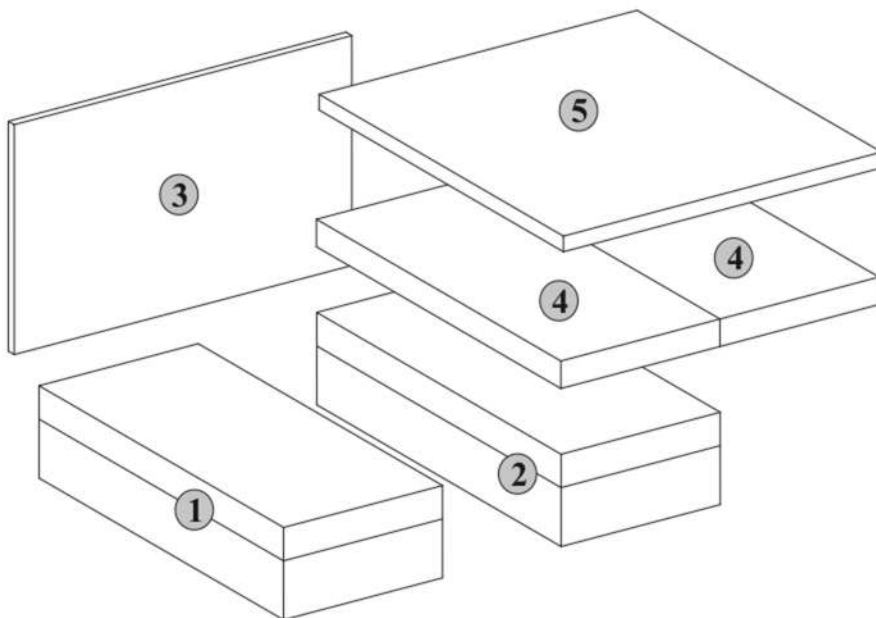

<b>1</b>	2000	900	420	x1	1/5
<b>2</b>	2000	900	420	x1	2/5
<b>3</b>	2000	900	170	x2	3/5
<b>4</b>	1930	1170	100	x1	4/5
<b>5</b>	2000	1800	80	x1	5/5

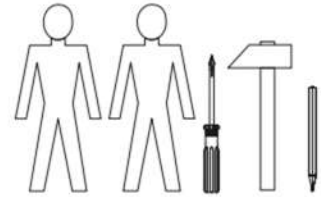
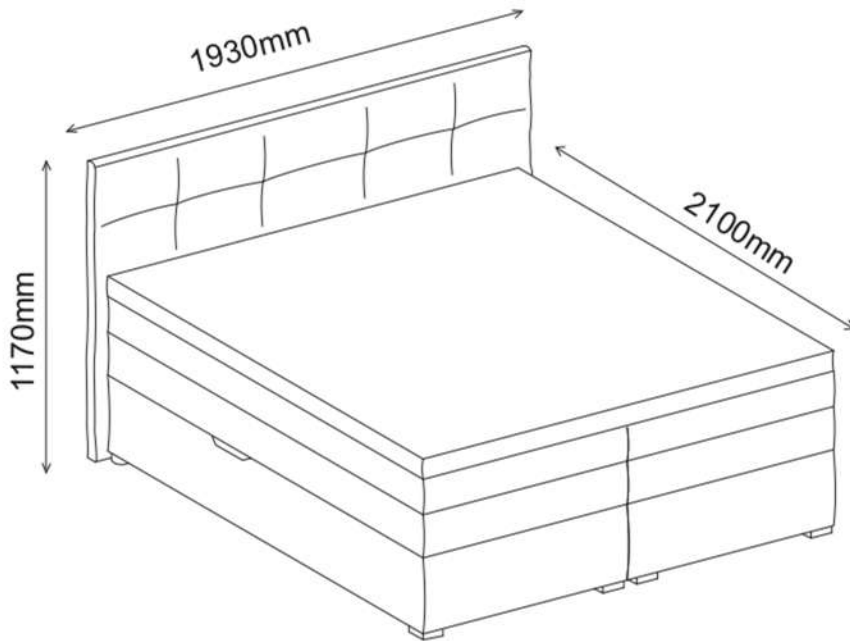
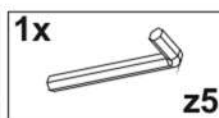
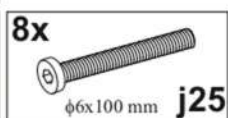
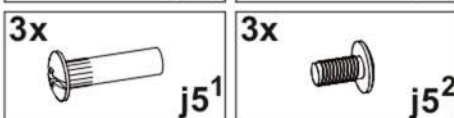
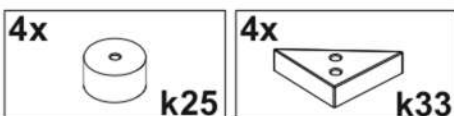

**1**



**x4**

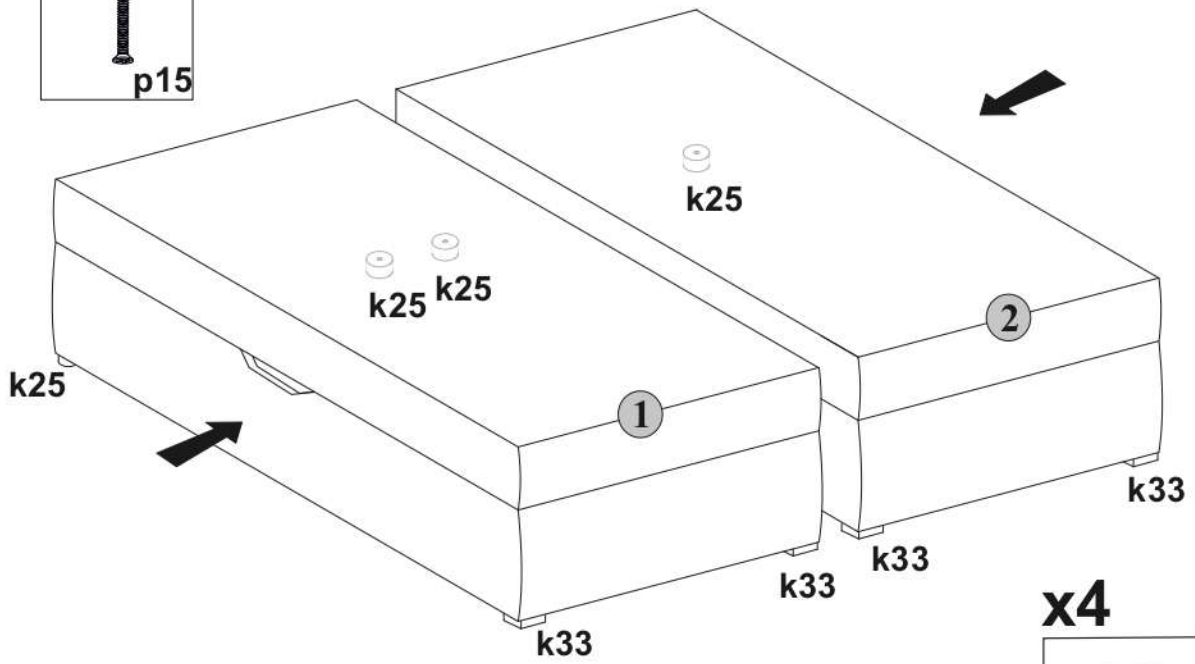

**x4**

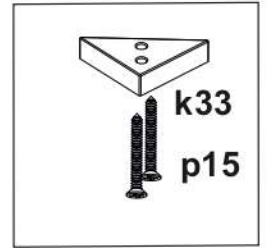

**2**

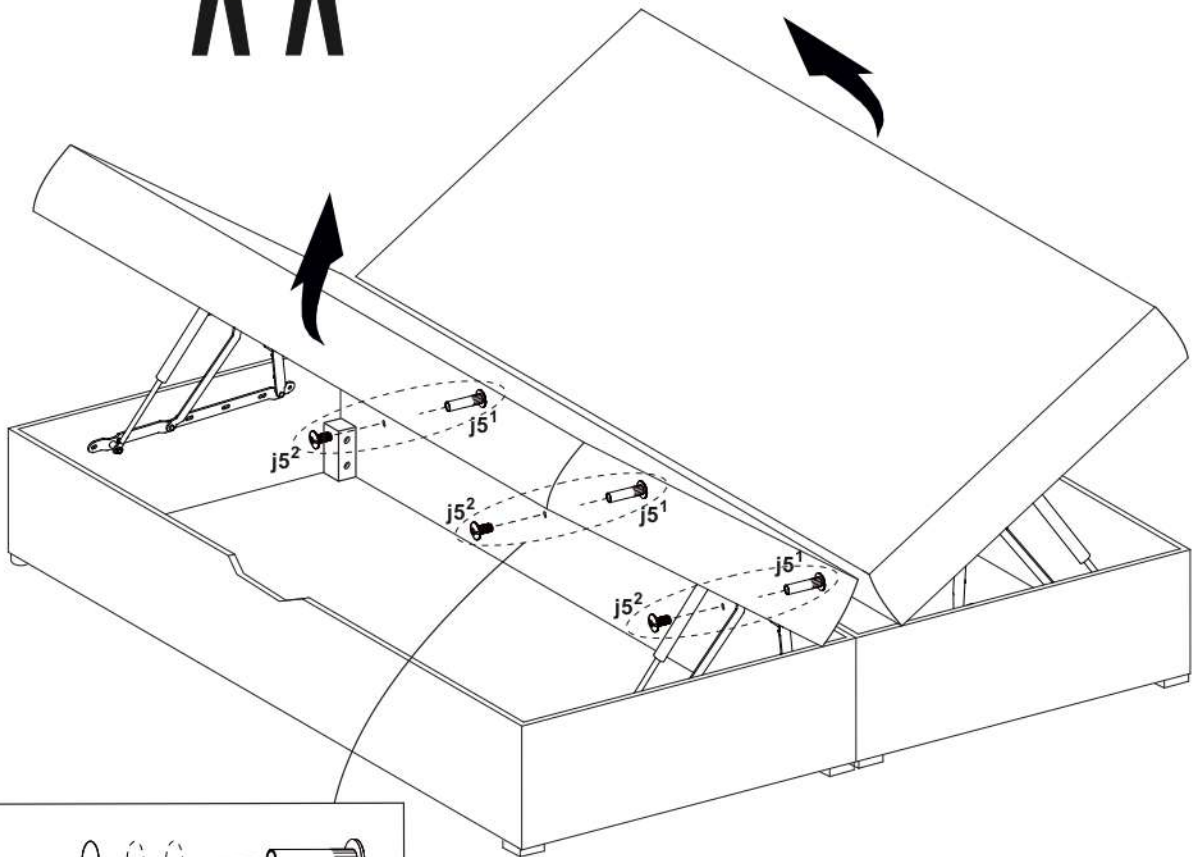

**x3**

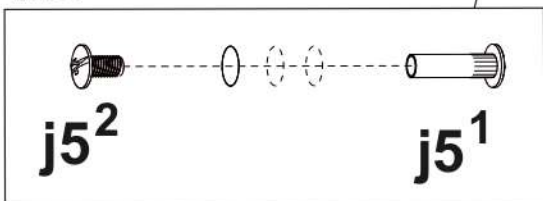

**2**

**3**

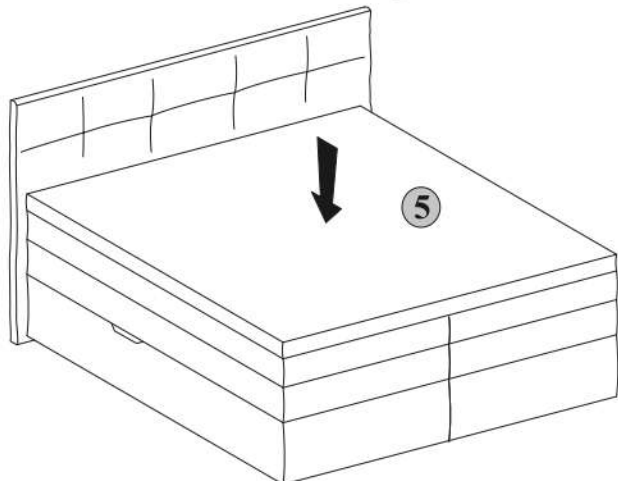
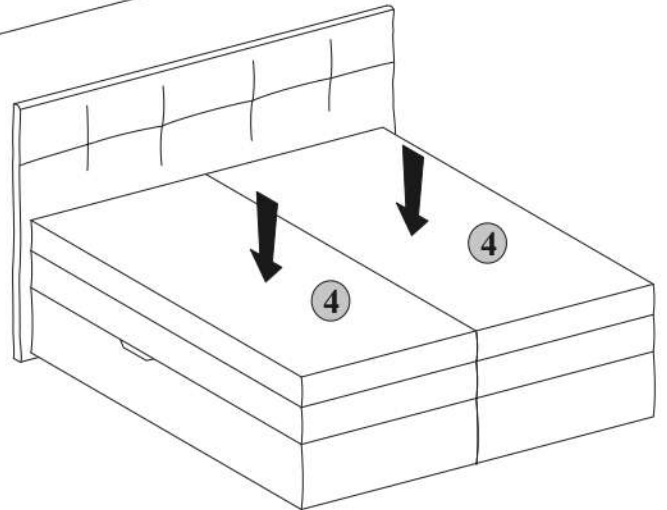
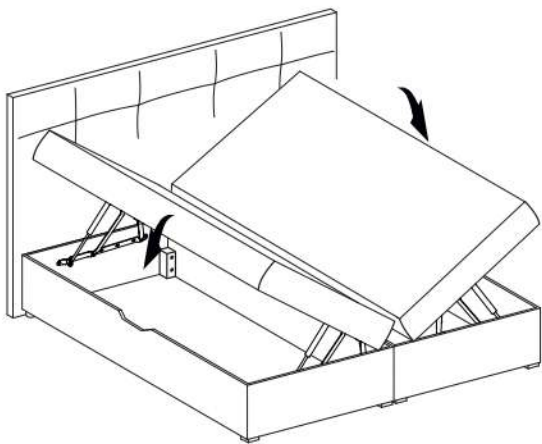
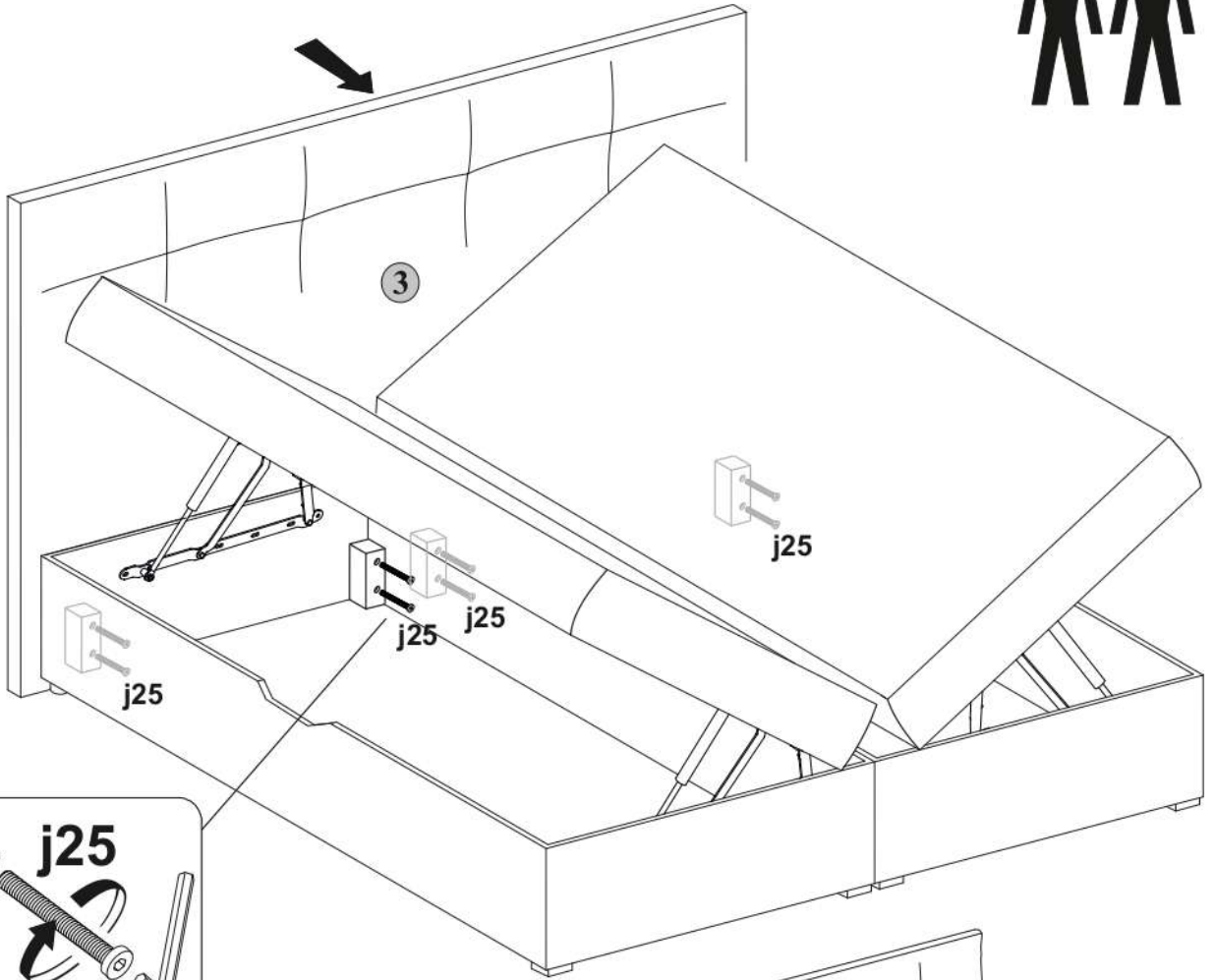

**3**